



Pallet Shuttle

A semi-automated high-density system for high-performance storage





The evolution of high-density storage systems: superior capacity, speed and output

The Pallet Shuttle is a semi-automated high-density storage system where an electric shuttle runs along rails inside the storage channels to load and unload pallets. This achieves higher storage capacity and increases the throughput of incoming and outgoing goods in the warehouse.

Logistics has become a key element in business management, since it allows for real competitive advantages. In this context, there is a greater focus on the design and implementation of warehouses that are more flexible and versatile, those able to adapt to the three most important demands of today's market: **a better variety of products, lower costs and a faster, quality customer service.**

Mecalux, mindful of shifts in business markets, has opted to develop high-density systems to assist companies in meeting these demands flexibly. In this regard, the high-density Pallet Shuttle storage system incorporates the latest technological innovations to enhance warehouse performance and profitability.

The shuttle moves autonomously, without forklifts needing to enter storage lanes, following the orders

sent by an operator through a Wi-Fi connected tablet.

The installation of the Pallet Shuttle system is especially useful in compact warehouses with consumer products, cold storage chambers, as well as temporary storage buffers or those for completed orders.

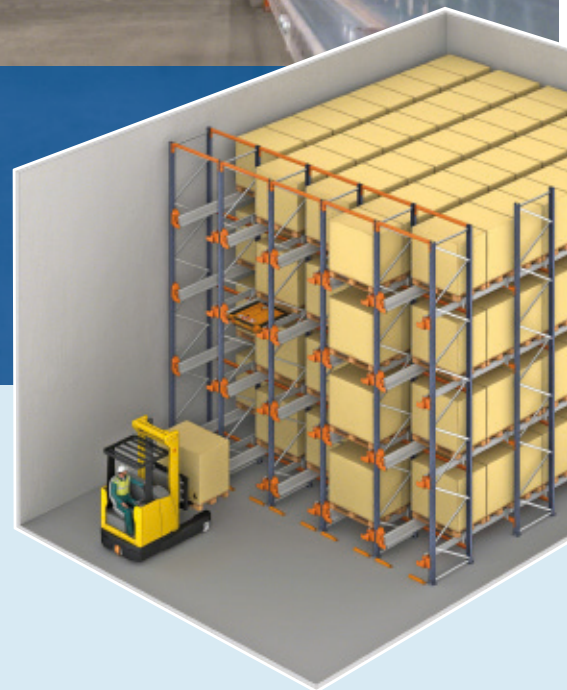



Index

Semi-automated Pallet Shuttle System

- 4 **Key advantages**
- 6 **How it operates**
 - 8 Load management systems
 - 10 Control system
- 12 **Distinctive features**
- 14 **Components**
 - 14 Shuttle
 - 16 Racks
 - 19 Accessories
 - 20 Safety features
- 22 **Possible distributions**
 - 22 Solution with a single aisle
 - 23 Solution with one work aisle and racks on both sides
 - 24 Solution with two access aisles
 - 25 Solution with two work aisles and lower levels for picking
- 26 **Uses**
 - 26 Combined with other systems
 - 28 Cold storage
 - 30 Clad-rack warehouses
 - 32 Pallet Shuttle with AGV/LGV
- 34 **Warehouse Management System Easy WMS**

An ideal solution for companies with a large volume of pallets per SKU and high loading and unloading workflows.

Key advantages

Technology applied at top operating speeds

Save space

Storage channels can be more than 40 m deep.

- The system works with minimal clearances between levels, which allows for **high-density storage**.
- Through the use of pallet sensors, the shuttles **can position loads intelligently**, eliminating empty spaces in the storage channels.

1

Save time

Loading and unloading times are reduced, since the forklifts do not access the inside of the storage lanes.

- **Rapid execution of orders:** the shuttle's travel speed reaches 90 m/min when unloaded or 45 m/min when loaded.
- Load lifting **cycle of just 2 seconds**.
- With a single command, the shuttle can **serially fill or empty a whole channel**.

2

Increase productivity

Product-to-person system: the load moves to the operator, optimising their movements.

- Ample **increase in the number of cycles/hour**.
- **The system is easy-to-use** and maintain.
- **Inventory control function**.

3





4

Cost savings

The high-density Pallet Shuttle system offers increased profitability, with reductions in short-term overhead.

- The **optimal use** of space helps shrink the floor area, with the resulting cost savings on land or rental expenditures.
- **Lower energy consumption**, particularly in cold storage installations because the floor area needed to be kept at low temperatures is scaled down.
- **Forklift use is eliminated** inside the storage aisles, which lowers maintenance costs: cutting down blows to the rack structure, less wear and tear from the misuse of the installation, etc.

5

Versatility

SKUs can be grouped by channels, instead of by entire lanes, allowing for greater warehouse diversity.

- **Any type of forklift can be used** to handle the shuttle.
- The shuttles can work with pallets of **different sizes and widths**.
- Each shuttle holds **up to 1,500 kg per pallet**.
- It is a **scalable system**.
- The system allows **different configurations** of the installation depending on the number of SKUs, the number of pallets and the movements required in each case.
- All shuttles can operate in either LIFO or FIFO mode by simply choosing the desired setting via the tablet.

6

Safety

Because of the way the structure is built, and given that forklifts do not need to drive into the lanes, the risk of incidents is practically non-existent, and the metallic structure is not damaged.

Both the racks and the shuttle **incorporate specific safety devices** so that the system functions properly and protects the operators and goods.

How it operates

Multiple functions at your fingertips



In semi-automated installations using the Pallet Shuttle system, forklifts deposit the pallets on the rails at the level's entrance. The electric shuttle picks them up and moves them to the first free location in the channel, compacting the load as much as possible.

The movement of the shuttles inside the racks is automated, following orders sent by an operator using a Wi-Fi connected tablet.



The Wi-Fi control tablet has a highly intuitive user interface.

The loading and unloading of pallets are carried out in four easy steps:



1

A forklift places the Pallet Shuttle in the channel where the work is to be done.



2

Next, the forklift is used to position pallets one by one in the channel entrance, resting them on the load profiles. The forklift never enters the rack structure.



3

Using the Wi-Fi connected tablet, the operator sends the command to the shuttle to start the loading operation. Once the location of the pallet has been identified, the shuttle lifts the pallet slightly and moves it horizontally until it reaches the first free location, where it is deposited. Different sensors accurately control the movement of the loaded shuttle.



4

The shuttle returns to the front of the channel to repeat the operation with the next pallet, and the next, as needed until the channel is full. Before the last position is filled, the shuttle is extracted and the sequence repeated in the next channel where work is required.

To unload the pallets, the operator carries out the same operation, but in reverse.



Load management systems

Semi-automated installations with the Pallet Shuttle allow two types of operations:

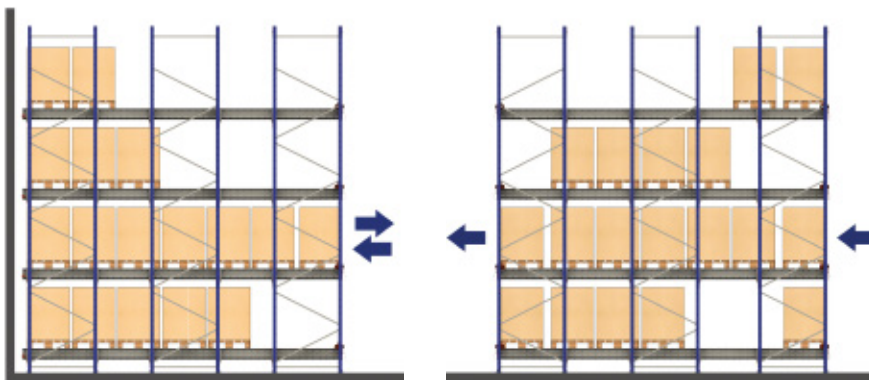

LIFO system

FIFO system

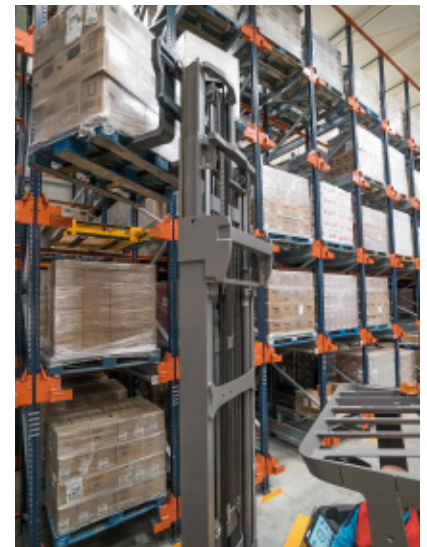

LIFO (last in, first out), the last pallet loaded is the first to be unloaded. Loading and unloading are done from the same side. This is the most common method used with the Pallet Shuttle system.

FIFO (first in, first out), the first pallet loaded is the first to be unloaded. Two access aisles are needed: one to load the goods and another to unload them.

When there are multiple channels with the same SKU, the FIFO method by load channels or batches can be carried out, through orderly emptying and filling of the channel.

It is the ideal system to create a buffer between two areas or when the aim is to maintain proper turnover.





Control system

The control system is responsible for communicating orders to the shuttle via the Wi-Fi connected tablet. The software is very easy-to-use, and does not require specialised training for proper usage. The operator only needs to select the desired function on the tablet's screen, which has a very user-friendly interface.

The main functions the semi-automatic Pallet Shuttle system can perform are:



Main functions	
1 Pallet selector	Selects the type of pallet to be handled
2 LIFO/FIFO configuration	Selects the load management strategy
3 Change of work aisle	Selects which side of the structure you want to work on (in FIFO mode)
4 Locking system	Activates the additional locking system, which increases the clamping between the Pallet Shuttle and the blades of the forklift. Activation can be manual or automatic.
5 Compacting	Compacts pallets at the beginning (LIFO) or end (FIFO) of the channel
6 Continuous loading/unloading	Uninterrupted loading/unloading of a channel
7 Partial unloading	Selects the number of pallets to be extracted
8 Inventory	Counts the number of pallets stored in the channel
9 Location signal	Activates light and sound signals, identifying the location of the chosen shuttle
10 User management	Manages shuttle user permissions for authorised personnel
11 Operating mode selector	Automatic or manual (for maintenance tasks)
12 Shuttle indicator	Shows the number of shuttles in operation and their status
13 Tiltmeter	Detects the incorrect position of the shuttle within the channel
14 Rescue	Recovers the damaged shuttle from within the channel
15 Position camera (optional)	Facilitates the insertion of the Pallet Shuttle on the rails



For safe, ergonomic access to the tablet, there is a support attached to the forklift's protective roof structure, or to one of the vertical cabin profiles. Thus, the tablet fits into the support stand and can be removed easily.



Distinctive features

Technological innovation offers maximum performance

The shuttle is the most distinguishing element of this storage system. It moves mechanically and autonomously thanks to various electronic components (PLC, batteries, antennas, sensors, etc.). Among its most distinguishing features are:



It is possible to **manage up to 18 shuttles** with a single control tablet.

Inventory function. The shuttle can count the number of pallets stored in the channel.

Easy WMS warehouse management software by Mecalux can be installed on a tablet.



All shuttles can **operate in LIFO or FIFO mode**. The operator uses the tablet to select the desired work mode.

The shuttle is equipped with **sensors to detect and handle pallets** of different sizes and widths.

The shuttle **operates with lithium batteries**, which provide an autonomy of up to 10 hours at full power, depending on the temperature and load conditions.

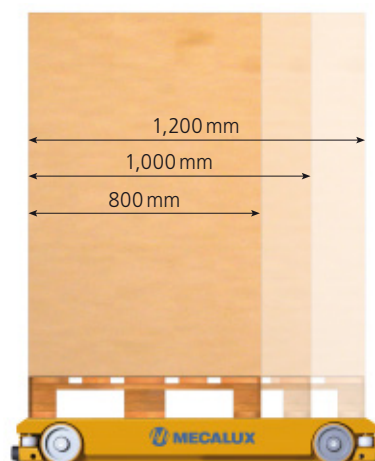
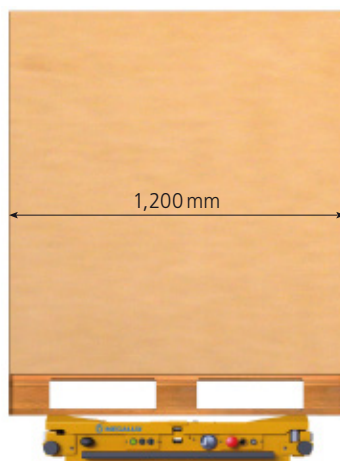

1,500 kg

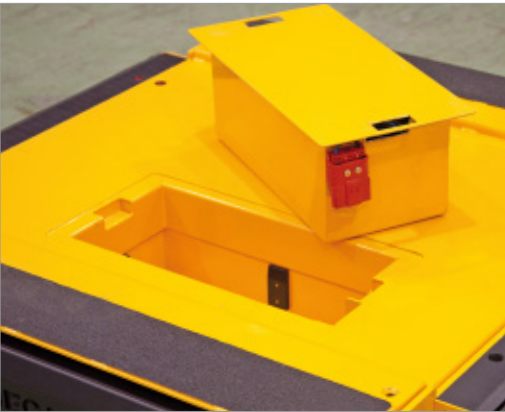

The **easy-access lithium batteries** have fast, wireless connections, so that they can be changed quickly without interrupting the operational cycle.

The shuttle platform is designed to **carry pallets with a buckling limit of up to 25 mm.**

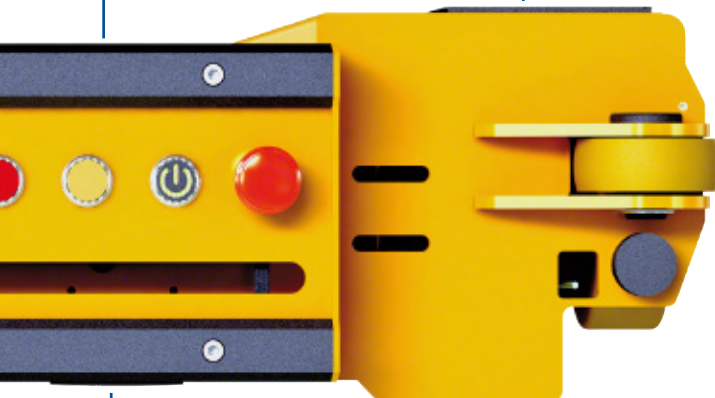
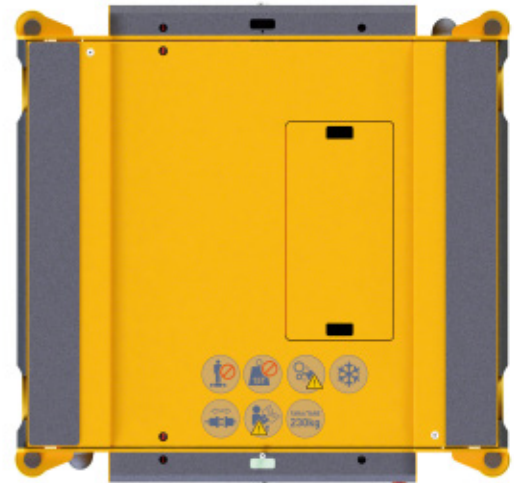

Adapts to temperatures between -30 °C and 45 °C.

It is a **scalable system.** Over time, the number of shuttles can easily be increased as productivity rises.

Shuttle technical data	
Pallet width	1,200 mm
Pallet depth	800 / 1,000 / 1,200 mm
Load capacity	Up to 1,500 kg
Wheels	4
Unloaded travel speed	Ambient: 90 m/min Cold: 55 m/min*
Loaded travel speed	45 m/min
Lifting time	2 s
Working temperature	Ambient: 5 °C to 45 °C Cold: -30 °C to 5 °C
Batteries	Lithium

*For loads of up to 1,500 kg



Rail height

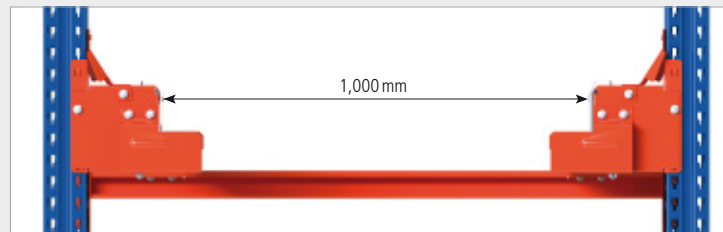

Width between rails

Components

Safety and control: the aim of the constructive system

The shuttle

It is designed for maximum speed and safety, with various devices to avoid incidents caused by improper use.



- 1. Wheel
- 2. Contrast wheel
- 3. Shuttle stops
- 4. Aerial
- 5. Safety bumper
- 6. Safety scanner (optional)
- 7. Lifting platform
- 8. Battery compartment
- 9. Fault indicator
- 10. Battery status indicator

- 11. On/off switch
- 12. Emergency stop button
- 13. End-of-track sensor
- 14. Position camera (optional)
- 15. Pallet detector
- 16. Locking system

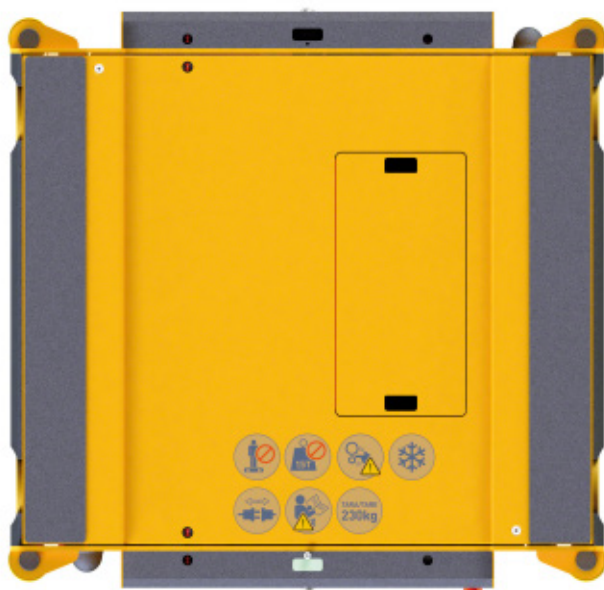
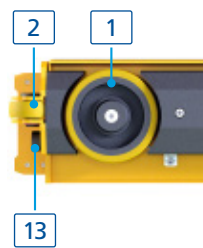
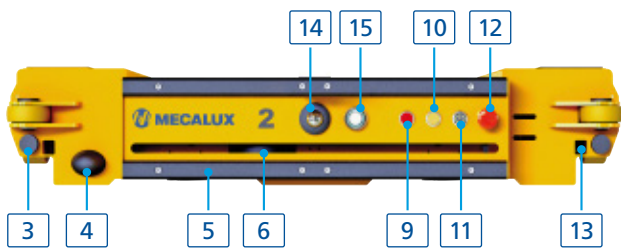

Top view



Bottom view



In high-rise installations, it is very useful to incorporate a positioning camera (14) in the moving equipment.

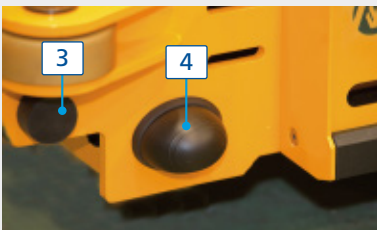

Shuttle stops (3): used to prevent possible collisions or incidents resulting from improper use.
Aerial (4): receives orders transmitted via Wi-Fi from the control tablet.



Safety bumper (5): used to prevent potential jams or collisions.



Safety scanner (optional) (6): installed on either side of the Pallet Shuttle for safer access control to channels while the shuttle is operating.



Emergency stop button (12): ensures the Pallet Shuttle stops for any preventive maintenance tasks.



Positioning camera (optional) (14): helps the operator to centre the shuttle between the two rails.

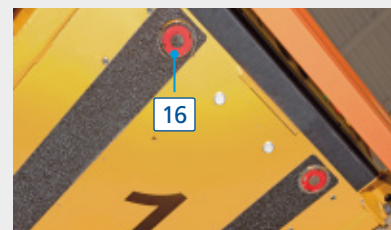

Locking system (16): ensures the fastening of the shuttle on the lifting blades of the forklift, preventing it from moving during travel.

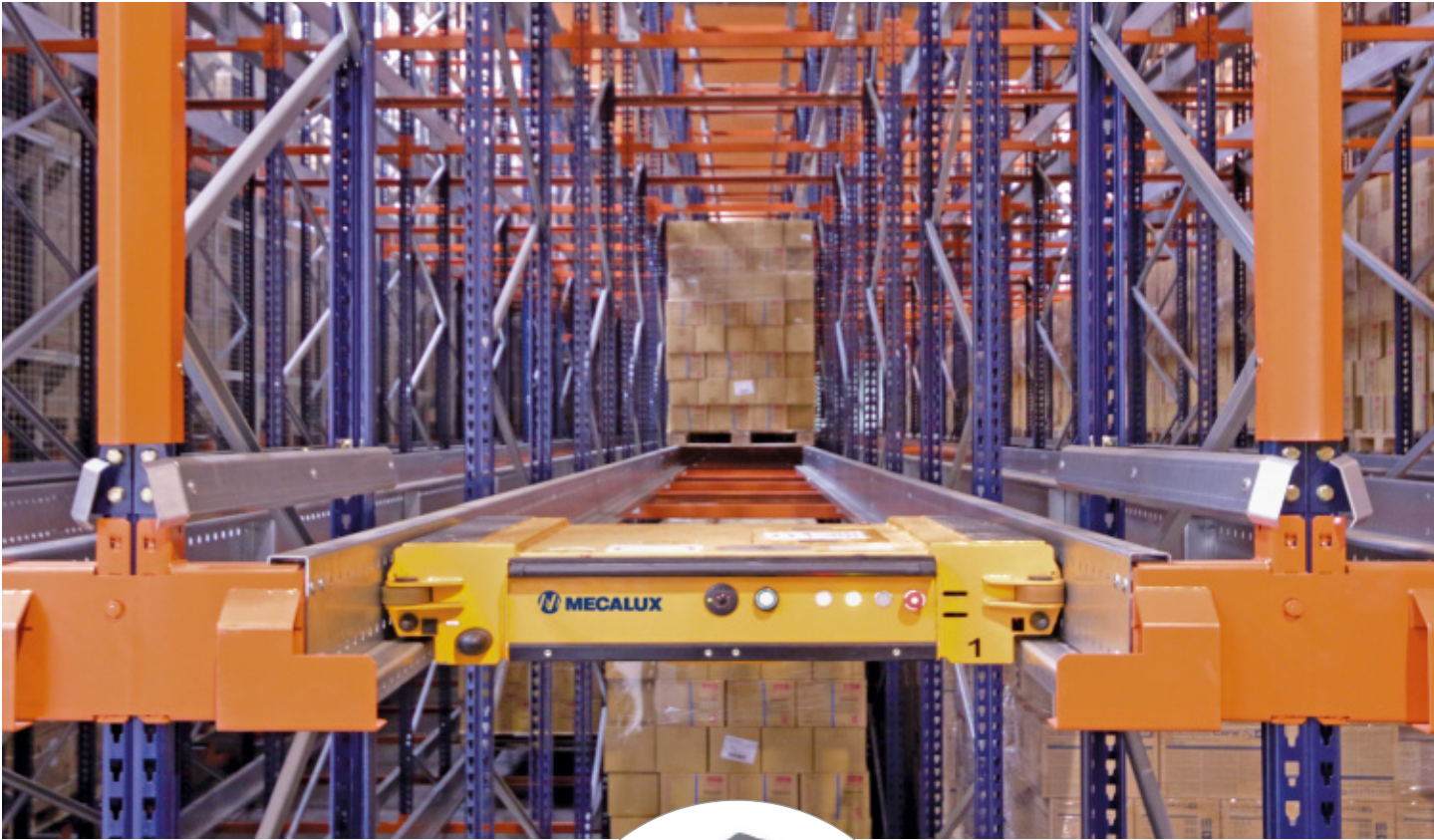

Racks

Structural components

For the shuttle to be able to travel safely within the storage channels, the rack structure needs to be adapted. It incorporates the following elements:

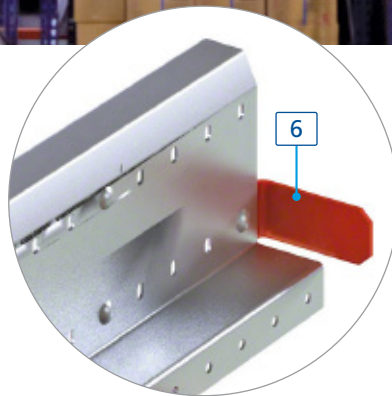

Rail stops

These stops slow and stop the shuttle in normal working conditions.

They also serve as a reference point for the shuttle, as they indicate the limit switch of each level.

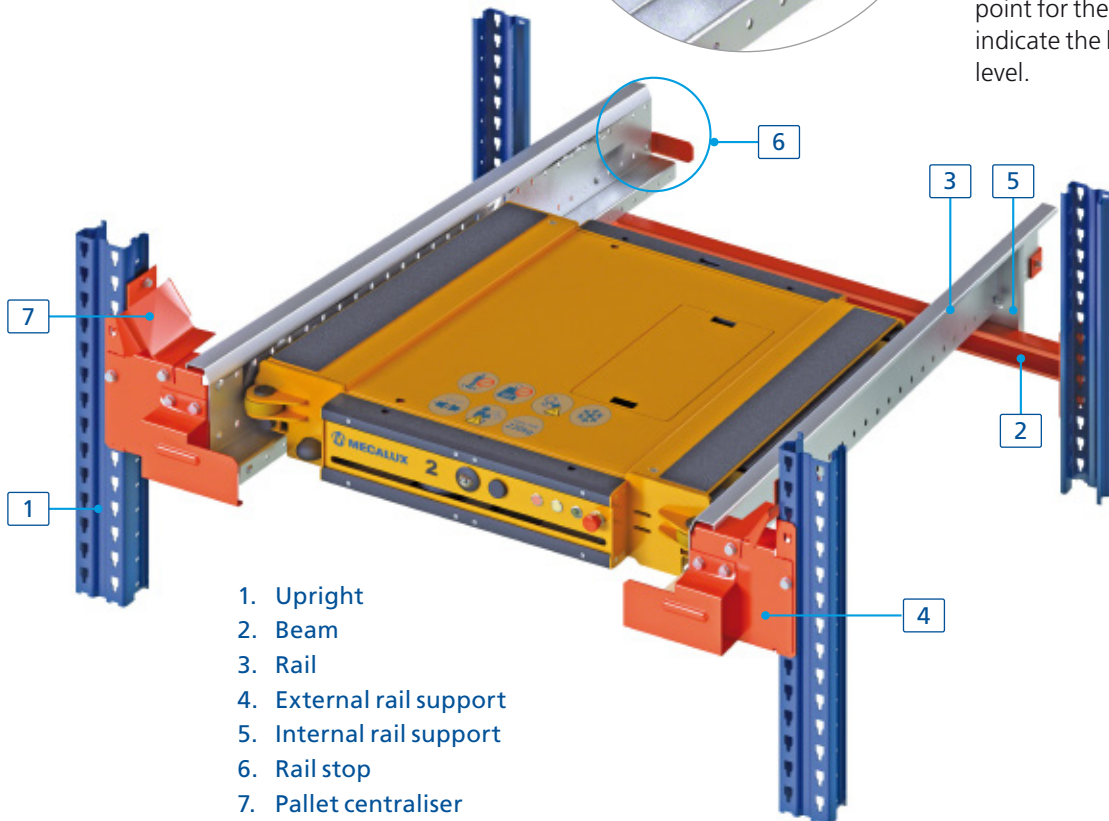

1. Upright
2. Beam
3. Rail
4. External rail support
5. Internal rail support
6. Rail stop
7. Pallet centraliser



Pallet centraliser

Located in the entry/exit of the storage channels, it eases positioning and centres the unit load in the channel.

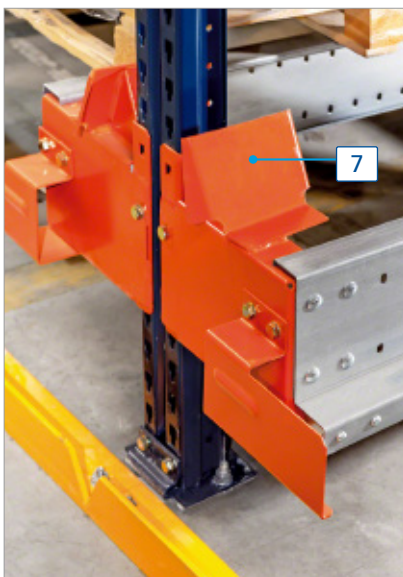

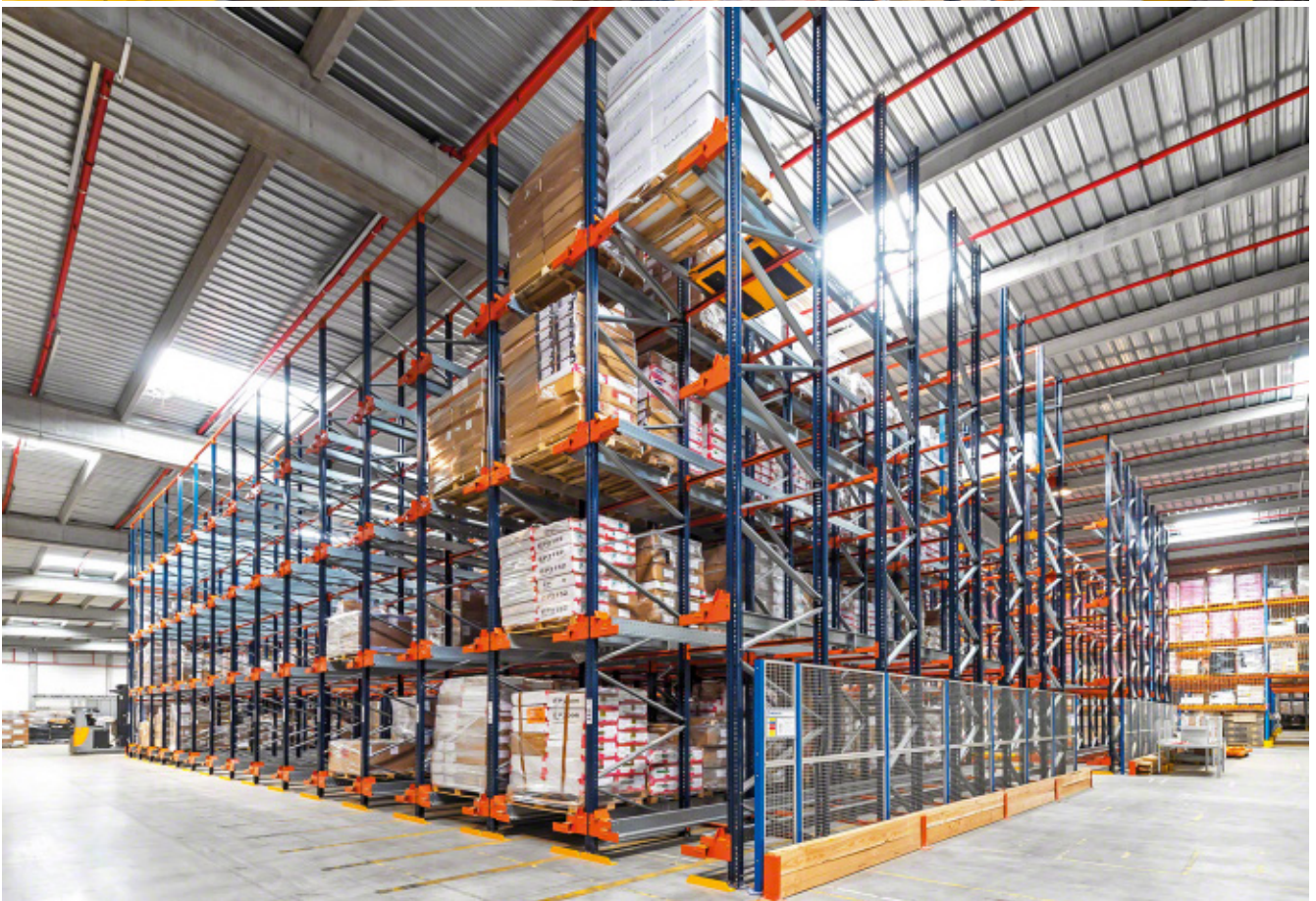



Load structures

They fulfil dual functions: to deposit shuttles when they are not in operation or to couple them to the charge stations, by either directly charging the batteries without removing them from their housing or charging the unattached batteries.

These types of structures are suitable when several shuttles are available and, especially, when they operate in cold conditions, since they must be removed from the refrigerated area when they are not operative. This avoids the energy consumption required to heat the electronic elements.

Accessories

Charging station

These are charging units with a straightforward, slid-in housing that connects to the batteries and, in addition, includes a separate cable to charge the shuttle without removing the battery.

It can be placed directly on a wall or in load structures.





Safety elements

Due to the interaction of people with the different handling and storage equipment, certain risks should be minimised as much as possible.

The accessories specified below help to ensure safety in warehouses using Pallet Shuttles.

Safety enclosures

2.20 m high safety mesh or fencing must be installed in all open spaces where the channels can be accessed –like on the sides– except in the front that faces the working aisle.



Anti-fall mesh

It must be placed over the full height of the rack that coincides with passageways or work areas when there is a risk of loose boxes falling, as can happen on higher racking levels with the Pallet Shuttle if the merchandise is not shrink-wrapped or strapped down.

Only the front is exempt from its placement, since this is where loading and unloading operations take place.



Front and side protection

The front protection delimits for the operator how far they can move with the forklift, to avoid hitting the racks.

Lengths of profiles can be placed in these areas that coincide with forklift wheels or an entire profile. Both options are suitable. So, the user must choose the one that best fits their requirements.



Protection of work aisles located at the bottom of the racks

The top of the picking aisles located below the racks should also be protected by mesh that prevents boxes from falling on the operators.

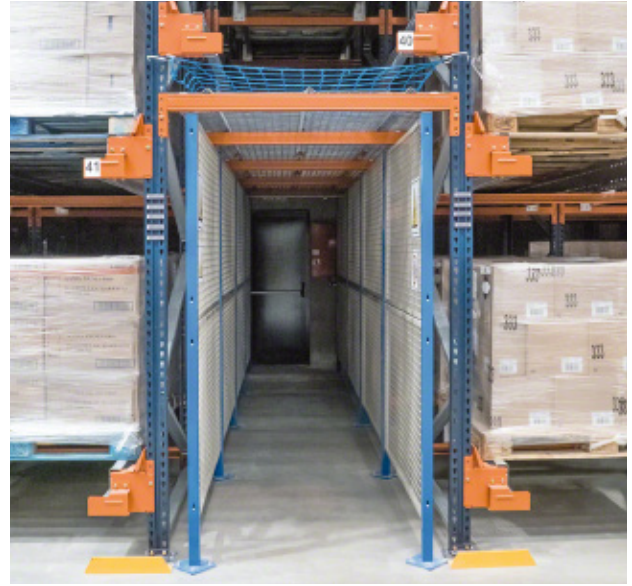

Underpass protection

When passageways need to be enabled below the racks, especially as emergency exits or maintenance passageways, safety enclosures must be installed on both sides and the upper part must be secured with mesh.



Painted floor markings

Lines painted on the floor mark out the area restricted to people, except for maintenance work. These lines must be painted in front of the area corresponding to rack loading a/o unloading.



Safety signs and pictograms

These warn of existing risks and describe the characteristics of the installation.

Possible distributions

Different options for the best solution



In general, the Pallet Shuttle system noticeably increases warehouse productivity when working with incoming and outgoing goods, and a large number of pallets per SKU.

Depending on certain factors, such as the warehouse dimensions, the number of SKUs, the required storage capacity, the load management system or the required flows of goods, opt for one distribution or another.

Below, it presents the four most common distributions. However, other alternatives are also possible when putting together the most appropriate solution for each company.

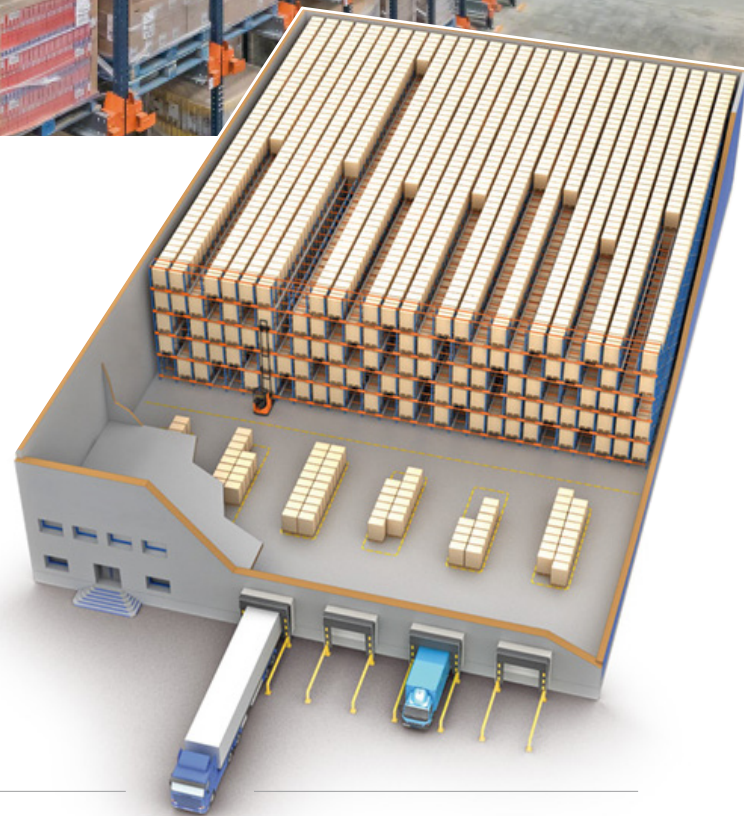

1 Solution with a single front aisle

The warehouse consists of a single racking unit with only one access or front aisle, which separates the racking from the reception a/o dispatch areas.

The load management system is LIFO, the pallets enter and are extracted from the same side.

This option offers greater storage capacity, i.e., a higher number of locations.

The more channels are allocated to one SKU, the more the effective capacity of the installation (the inflow and outflow of goods) reaches the physical location capacity, as there will be more fully loaded channels.

Solution 1.
A warehouse with the semi-automated Pallet Shuttle system consisting of a single rack structure with only one access.

Hence, it is particularly apt when there are few SKUs, and many pallets per SKU.

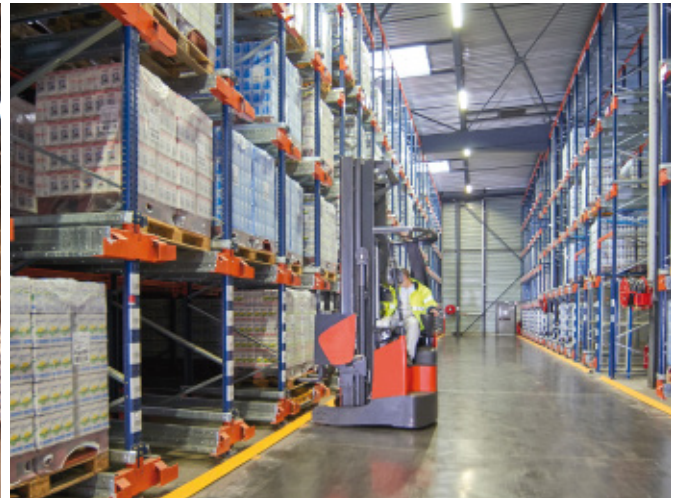

2 Solution with one work aisle and racks on both sides

The warehouse consists of two racking bays with a work aisle arranged in between.

It is also utilised for LIFO load management operations.

By installing racks on either side of a work aisle, more storage channels are created. The channels are not as deep, allowing more channels per SKU and increasing the effective capacity of the warehouse.

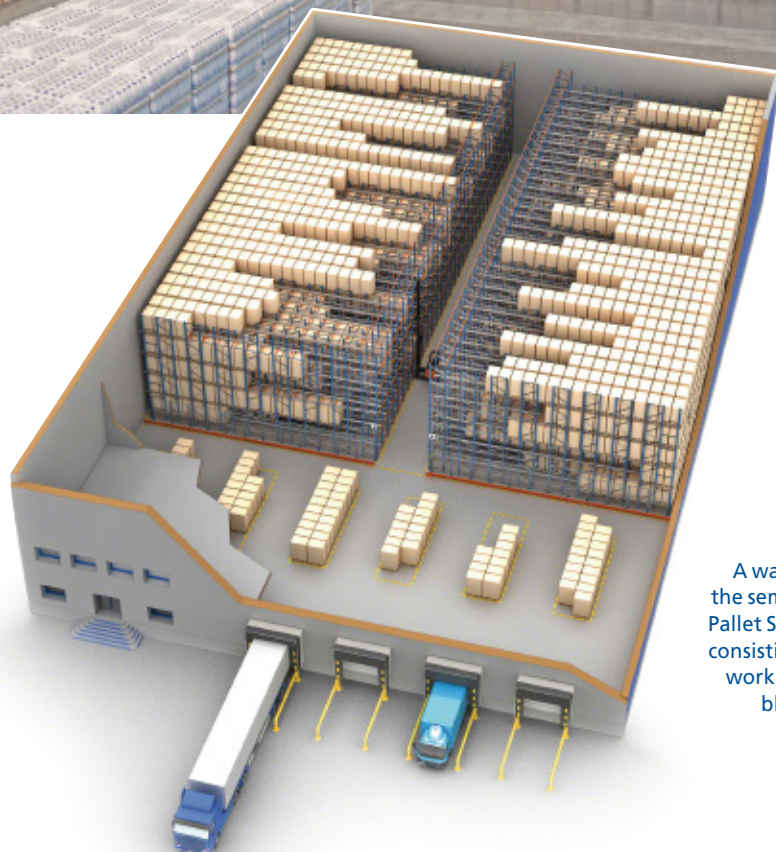

Solution 2.
A warehouse with the semi-automated Pallet Shuttle system consisting of a single work aisle and two blocks of racks.



3 Solution with two access aisles

A warehouse consisting of a single racking block with two access aisles: one for incoming goods and the other for outgoing goods.

Therefore, the FIFO load management method will be applied, since pallets enter from one side and leave from the other. By having two aisles, there is no interference between the forklifts loading the pallets and those unloading them.

In this type of distribution, it is recommendable to fully load and unload channels to minimise the relocation of pallets within the channel.

This is the ideal choice when the warehouse acts as a buffer (a temporary warehouse with short stays and full loads).

Solution 3.
A warehouse with the semi-automated Pallet Shuttle system and two access aisles.

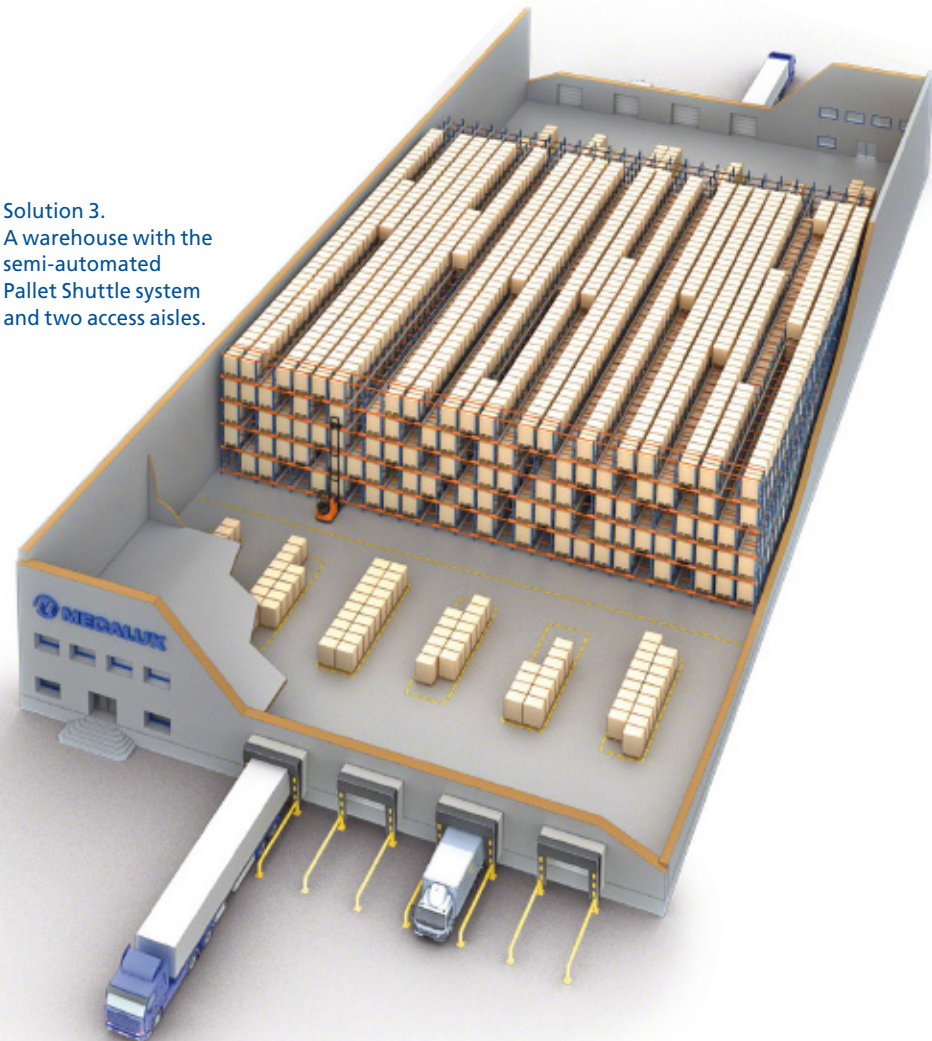

4 Solution with two work aisles and lower levels for picking

A warehouse consisting of two racking blocks combined with live levels for picking and two work aisles on both sides of the racks.

With this option, some storage capacity is lost in the picking area, by enabling massive order preparation. The racks on the highest levels serve as a reserve warehouse to supply the live picking levels located at the bottom.

Solution 4.
A warehouse with the semi-automated Pallet Shuttle system with two blocks combined with live levels for picking.



Uses

The ideal system for high-density storage

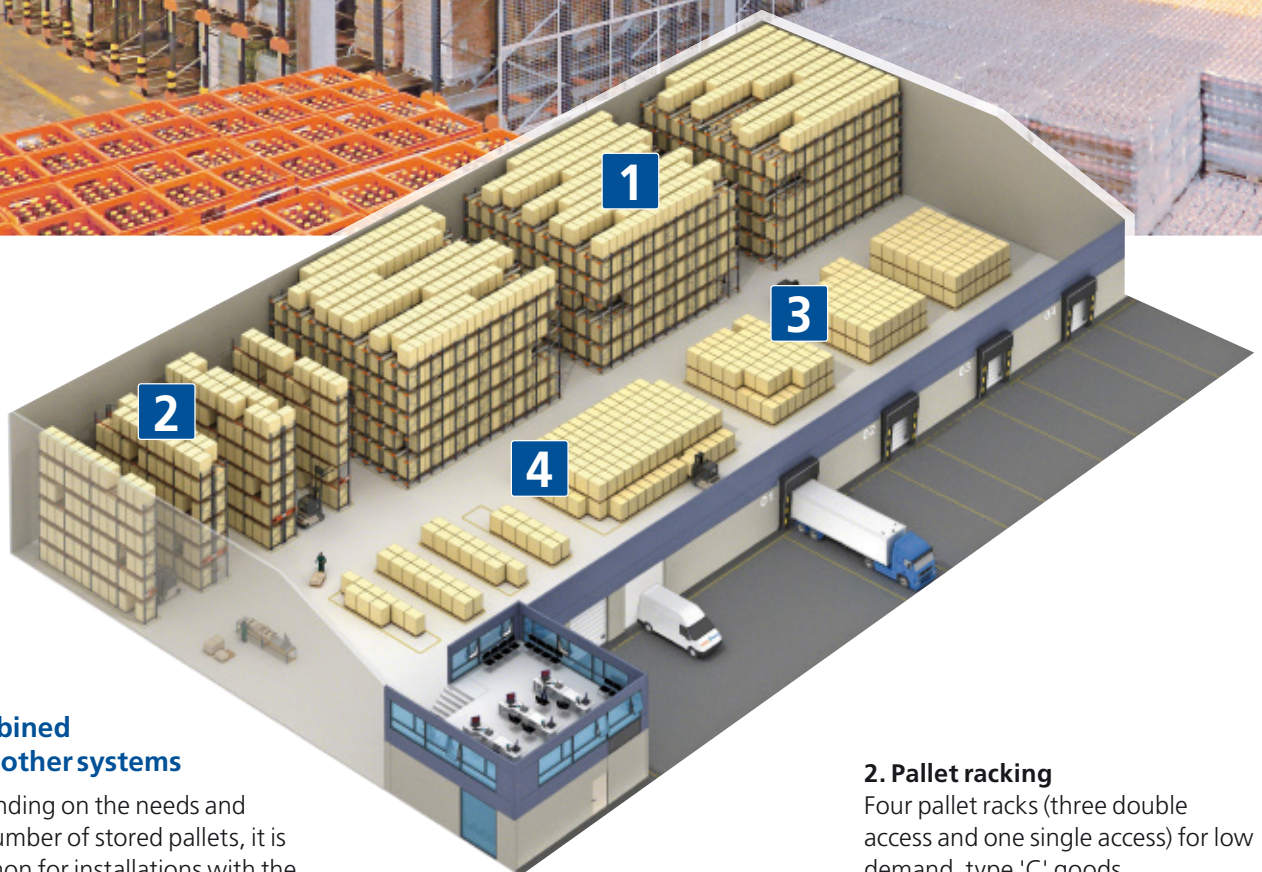

Combined with other systems

Depending on the needs and the number of stored pallets, it is common for installations with the Pallet Shuttle to be combined with other storage systems.

In the example shown here, different systems have been installed based on product turnover, using reach trucks and pallet trucks as handling equipment.

1. High-density, semi-automatic Pallet Shuttle system

Three blocks of high-density storage with a semi-automatic Pallet Shuttle, for medium demand, type 'B' goods.

2. Pallet racking

Four pallet racks (three double access and one single access) for low demand, type 'C' goods.

3. Stacking zones

Four stacking areas for reserve pallets of type 'A' consumer goods, located very close to the loading docks.

4. Prepared orders

Picking area for type 'C' products.



The Pallet Shuttle system is also a common means of combining racks or picking levels. There are various ways to setup picking channels under a rack structure with a Pallet Shuttle:

- Combined with live channels.
- Combined with ground-level channels.
- Combined with pallet racks.

Although these examples only show the combination of the Pallet Shuttle with one other system, more than two systems can coexist in an installation, each one dedicated to storing certain SKUs or to distinct operations.

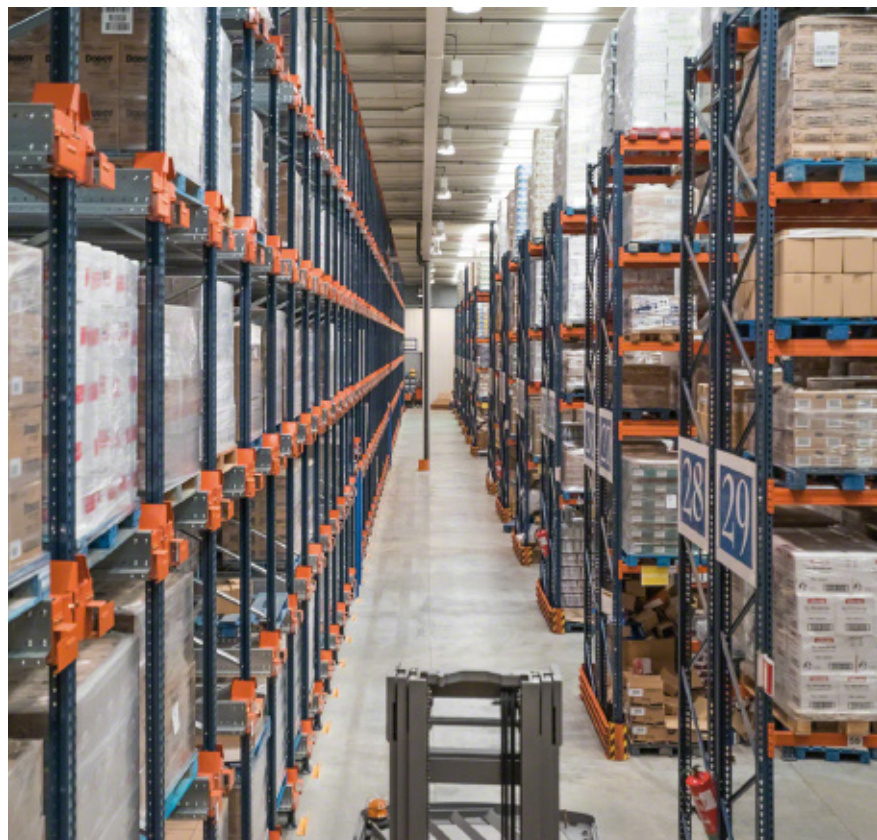

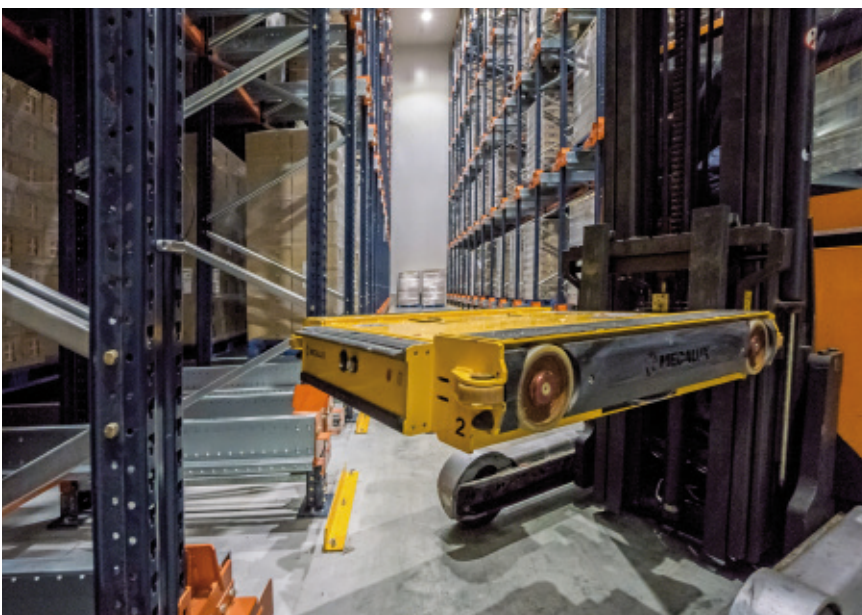

Cold storage

The implementation of the Pallet Shuttle in cold storage installations is ideal, making the most of the chamber's volume. This entails energy cost savings and a significant reduction in manoeuvring times.

Two determinants must be considered when designing the racks: the location of the evaporators or air conditioning equipment and the space needed to distribute the air flow correctly, mainly the part facing the equipment and the upper space between the merchandise and the chamber's ceiling.

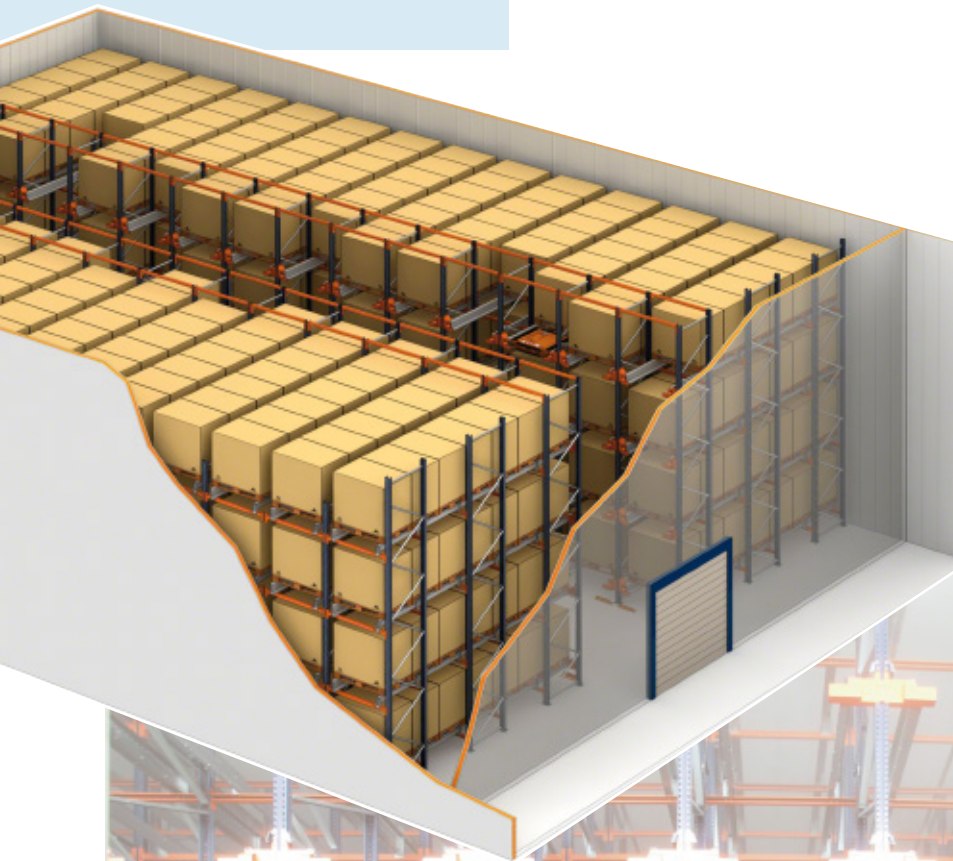

The distribution criteria can be the same as those applied to ambient temperature warehouses.



Clad-rack warehouses with the Pallet Shuttle

As with all other storage systems, a clad-rack installation is an option, where the racks themselves support the cladding and walls of the warehouse. In other words, they form the building itself, resulting in an integrated construction.

The warehouse can be allocated to store products at ambient temperatures or to create either a refrigerated or frozen storage chamber. The construction is very similar in both cases. The main difference lies in the thickness of the insulation in the cladding and the doors of the warehouse, in addition to the existence of the cold producing equipment in the case of cold storage chambers.



Images of a clad-rack warehouse dedicated to storing products at ambient temperature.



A clad-rack warehouse with a frozen product chamber.





Pallet Shuttle with AGV/LGV

An alternative solution to stacker cranes is the use of automatic forklifts. These perform movements from different production points or docks to the storage channels, where they deposit the pallet on the Pallet Shuttle.

In this solution, the forklifts are automatically guided by the AGV/LGV system. The position of the machines is controlled by triangulated signals, similar to how a GPS works.

The advantage of using AGV/LGV guided forklifts is that it eliminates the traditional automatic conveyor (roller conveyors, chain conveyors and electrified monorails). There are even pallet trucks guided in this manner.

It is an optimal system when there are few movements, heights of less than 8 m and different stations for pallet loading and unloading.

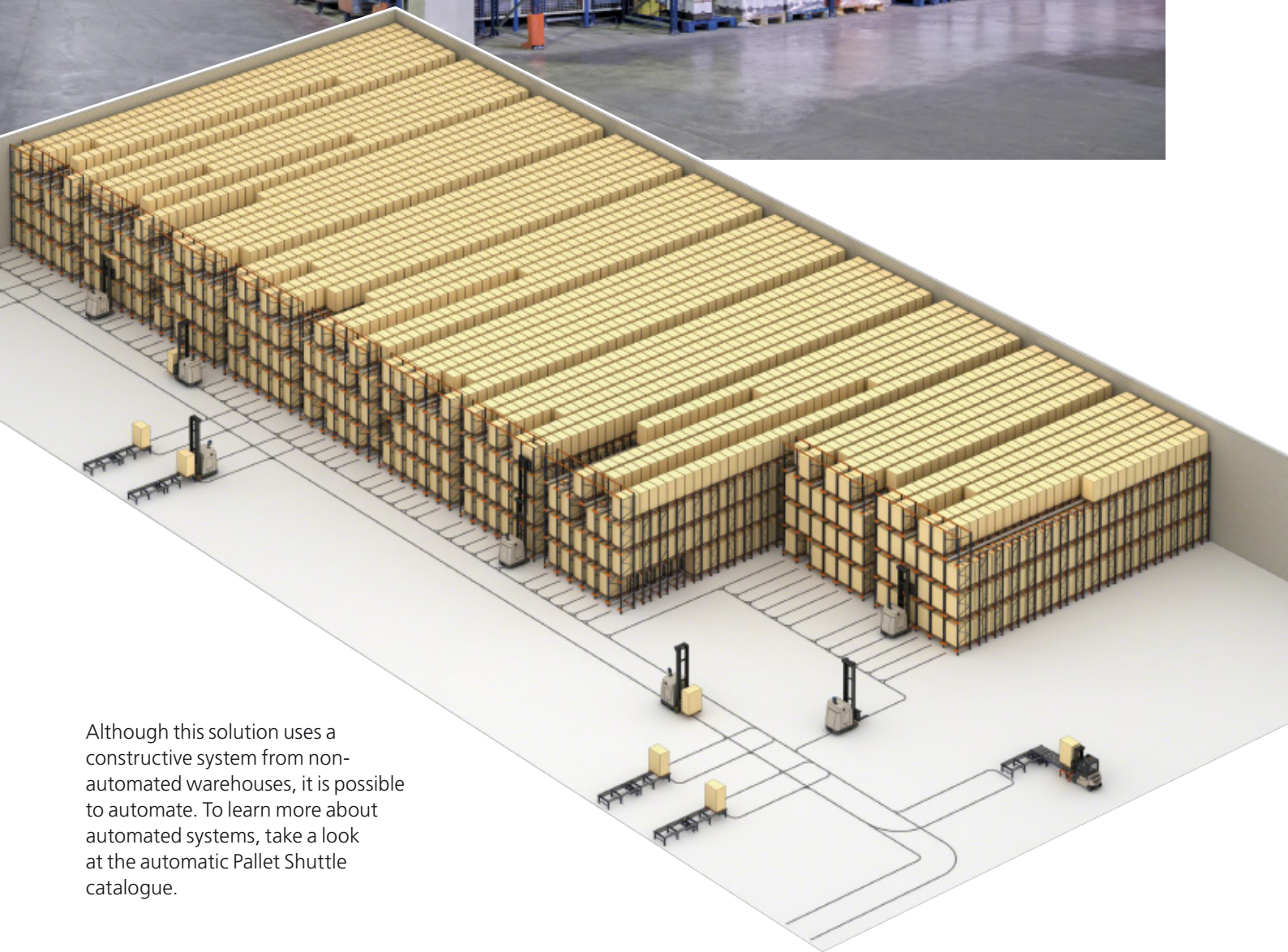

Although this solution uses a constructive system from non-automated warehouses, it is possible to automate. To learn more about automated systems, take a look at the automatic Pallet Shuttle catalogue.

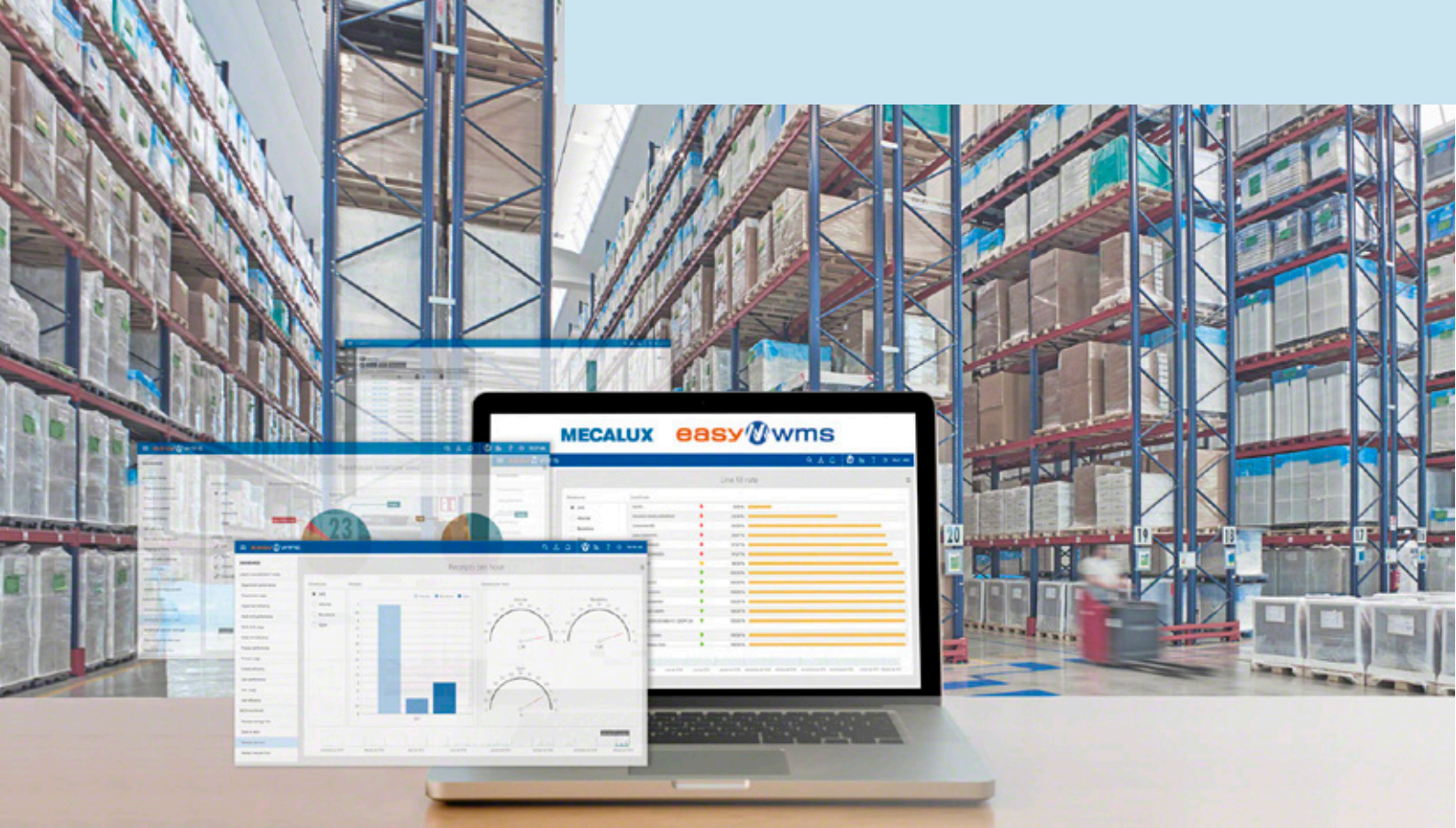

Easy WMS Warehouse Management System

The brain of the installation

Easy WMS is a powerful, versatile, scalable and flexible software program that can manage a manually operated warehouse (paper or radiofrequency device run), a mixed facility or a large automated warehouse with the same efficiency.

Use it to streamline physical product flows and document management, from warehouse inputs to dispatches, for guaranteed full end-to-end traceability.

Advantages

- > Receive real-time stock control
- > Lower logistics costs
- > Increase storage capacity
- > Reduce handling tasks
- > Eliminate errors
- > Get precise, high-speed picking
- > Adapt to new ecommerce needs
- > Manage omnichannel operations
- > Achieve a fast ROI (in 12-18 months)



Mecalux works with leading suppliers that attest to the quality, reliability and technical level of the Easy WMS platform:



Interconnected solutions for your supply chain



WMS for Ecommerce

Ensures efficient multichannel logistics. Optimises the logistics operations of online shops, regardless of their size, number of daily orders or storage capacity.



Multi Carrier Shipping Software

Automates product packaging, labelling and shipping. Coordinates direct communication between the warehouse and the various transport agencies.



Store Fulfillment

Synchronises inventory and workflows to ensure optimal stock management between the central warehouse and the network of brick-and-mortar shops.



WMS for Manufacturing

Facilitates traceability in manufacturing processes. Guarantees the continuous supply of raw materials to the production lines.



Supply Chain Analytics Software

Analyses the thousands of pieces of data generated daily in a warehouse, allowing the manager to make strategic decisions based on the real throughput of operations.



Marketplaces & Ecommerce Platforms Integration

Synchronises the stock in the warehouse with the online catalogue in real time. Easy WMS automatically connects to the main digital sales platforms and marketplaces such as Amazon, eBay and PrestaShop.



3PL Warehouse Management Software

Manages billing between a 3PL and its customers. A dedicated access platform provides information on stock condition and how to place orders or request customised shipments.



Labor Management System (LMS)

Maximises operational productivity. It objectively measures the throughput of operators, detecting opportunities for improvement for the company.



Warehouse de Slotting Software

Optimises slotting management in the warehouse. It determines the optimal slotting for each SKU based on a set of predetermined rules and criteria (historic, current and future demand).



Yard Management System

Supervises the movement of vehicles in the yard at the warehouse or distribution centre. Optimises loading dock operations to improve vehicle flow and avoid bottlenecks with entering and exiting goods.

Easy WMS in the cloud

- » **Lower initial investment** since in-house servers are not needed.
- » Faster, simpler **implementation**.
- » Easier, more affordable **technical support and maintenance**. Total security with Microsoft Azure.
- » Software **version up-to-date** at all times.
- » **Maximum availability** to guarantee business continuity.
- » **Fees adapted** to the needs of each business.



info@mecalux.co.uk - mecalux.co.uk

MECALUX UK LTD.

BIRMINGHAM

Tel. 0121 3336 602

Unit 8, Junction 6 Industrial Park
Electric Avenue, Birmingham B6 7JJ
West Midlands - (United Kingdom)

MECALUX, SA

HEAD OFFICE

Tel. + 34 932 616 913

Silici, 1
08940 Cornellà de Llobregat
Barcelona (SPAIN)

Mecalux has a presence in more than 70 countries worldwide

Offices in: Argentina - Belgium - Brazil - Canada - Chile - Colombia - Czechia - France - Germany - Italy - Mexico
Netherlands - Peru - Poland - Portugal - Slovakia - Spain - Turkey - United Kingdom - Uruguay - USA

